

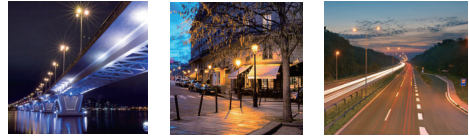

STREAM 150 PUBLIC SERIES

KAP-STB-150



Electrical / Electrique

Power / Puissance	140 W
Input voltage / Tension d'entrée	120 - 277 VAC
Input current / Courant d'entrée	1.8 A MAX
Frequency / Fréquences	50 - 60 Hz
Power factor / Facteur de puissance	> 0.9

Lighting / Eclairage

Beam angle / Angle de faisceau	90°X120°
Efficiency / Efficacité	112 Lumens/w
Lumen output / Sortie lumens	15700 Lumens
CRI / IRC	> 80
Color temperature / Température de couleur	3000 - 3500 K 4000 - 4500 K 4800 - 5100 K 5200 - 5700 K

Components & fixture / Composants et structure

Body material / Matériau du corps du projecteur	Aluminum / Aluminium
Product painting color / Couleur de la peinture	Silver grey / Gris argenté
Screws material / Matériau des visseries	Stainless steel316 / Acier inoxydable316
Cover material / Matériau du couvercle	PC lens / Lentilles en Polycarbonate
Cable specifications / Spécifications du cable	HO5RNF (3G1.0mm ²)
LED Chipset / Puces LED	Lumileds Luxeon 3030
Cable length / Longueur du cable	0.5m / 1.0m

Temperatures / Températures

Storage temperature / <i>Température de stockage</i>	-20°C ~ +40°C
Operating temperature / <i>Température d'utilisation</i>	-20°C ~ +40°C
Storage Humidity / <i>Humidité de storage</i>	10% - 90%

Additional product data / Informations supplémentaires

Lifetime / <i>Durée de vie</i>	> 50.000 Hours
Warranty / <i>Garantie</i>	5 years / 5 ans
International Standards / <i>Normes internationales</i>	Eco-Design(ERP)



Model number / Numéro de référence

Example for STREAM 150 with silver painting / color temperature 4000K / 0.5m cable
Exemple pour STREAM 150 avec peinture argentée / couleur de température 4000k / cable 0.5m

KAP -STB -150 -S 4 -C05

STREAM series with Lumileds LED chipsets
Gamme STREAM avec puces LED Lumileds

Power / *Puissance* : **150w**

Product painting color / *Couleur de la peinture*
Silver grey (Gris argenté)

Cable length / *Longueur du cable* :
0.5m / 1.0m

Color temperature / *Température de couleur*
3(3000-3500K)
4(4000-4500K)
5(4800-5100K)
6(5200-5700K)

Product Dimensions

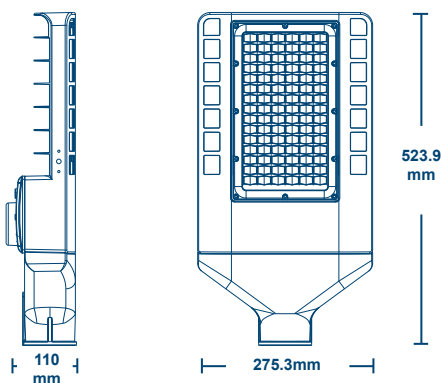

Photometry / Photométrie

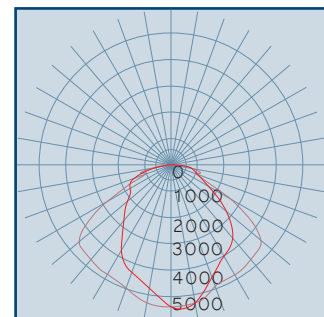

Packing Information / Information Colisage

Packing details	Size (mm)	Qty / ctn(pcs)	Net Weight (kg)	Gross Weight (kg)
Product	523*275*109	/	5.5	/
Inner box	535*285*130	1	/	5.6
Master Carton	545*295*280	2	11	11.2